

Structural Diagram



BSIDE

**Specification:**

- 1.Low Loss IL:  $\leq 0.25\text{dB}$
- 2.Return Loss:  $\geq 55\text{dB}$
- 3.Operation Environment:  $-40\sim+85^{\circ}\text{C}$
- 4.Storage Environment:  $-40\sim+85^{\circ}\text{C}$

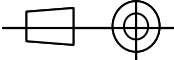
		<b>SHENZHEN OPTICO COMMUNICATION CO., LTD.</b>							
Model	LCUPC-StUPC SM G657A2 Duplex 2.0/3.0mm Yellow LSZH CPR-Dca Cable						OP-2F-LCStU-FP-2.0/3.0-SM-DX		
FIRST ANGLE PROJECTION 	MATERIAL	UNIT	SCALE	SIZE	SHEET	DRAWN	XUELING W	DATE	2025.04.29
	LSZH	m	/	A4	1	CHECKED	Michael Liu	DATE	2025.04.29
							APPROVED	STEVEN Zhang	DATE

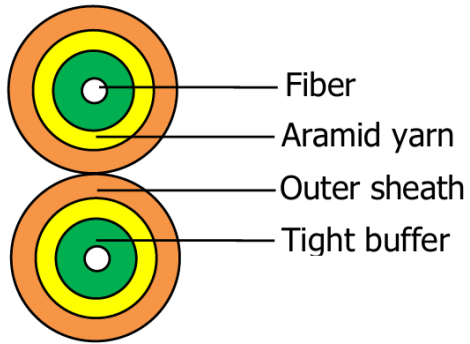
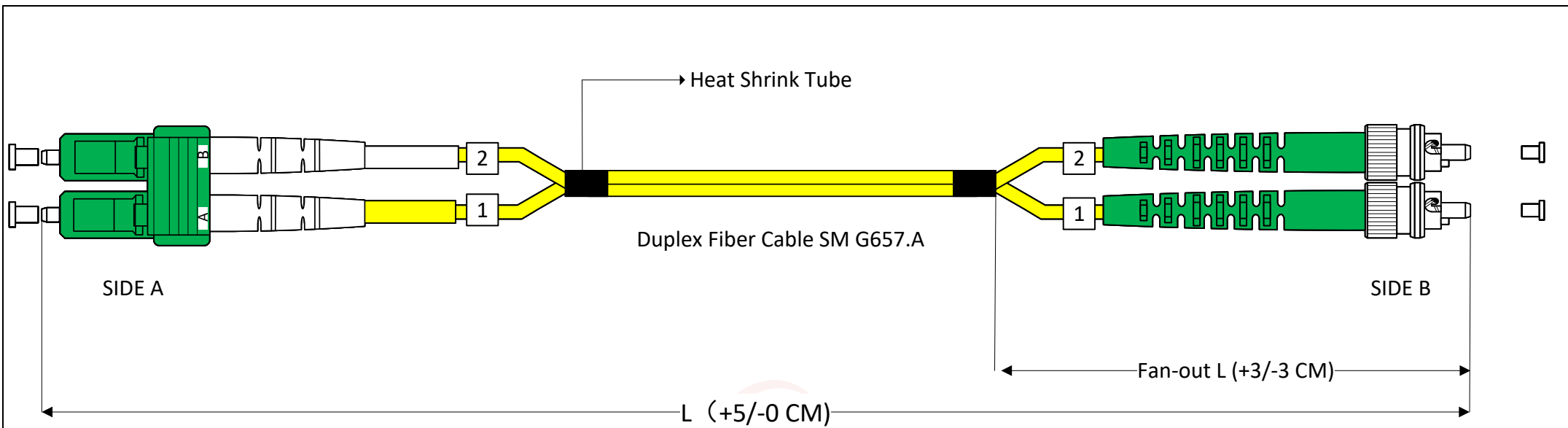

Structural Diagram

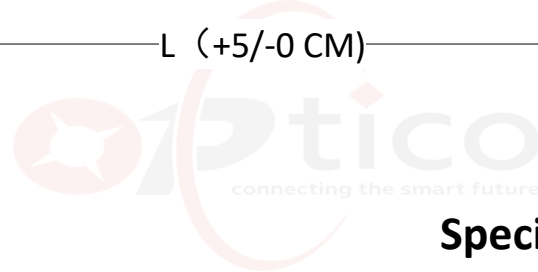

### Specification:

- 1.Low Loss IL:  $\leq 0.2\text{dB}$
- 2.Return Loss:  $\geq 65\text{dB}$
- 3.Operation Environment:  $-40\sim+85^{\circ}\text{C}$
- 4.Storage Environment:  $-40\sim+85^{\circ}\text{C}$

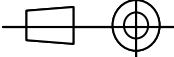
		<b>SHENZHEN OPTICO COMMUNICATION CO., LTD.</b>							
Model	LCAPC-STAPC SM G657A2 Duplex 2.0/3.0mm Yellow LSZH CPR-Dca Cable						OP-2F-LCSTA-FP-2.0/3.0-SM- DX		
FIRST ANGLE PROJECTION 	MATERIAL	UNIT	SCALE	SIZE	SHEET	DRAWN	XUELING W	DATE	2025.04.29
	LSZH	m	/	A4	1	CHECKED	Michael Liu	DATE	2025.04.29
							APPROVED	STEVEN Zhang	DATE

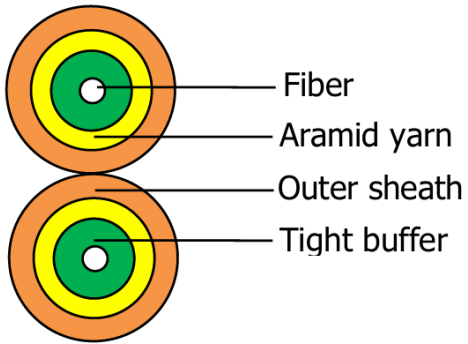
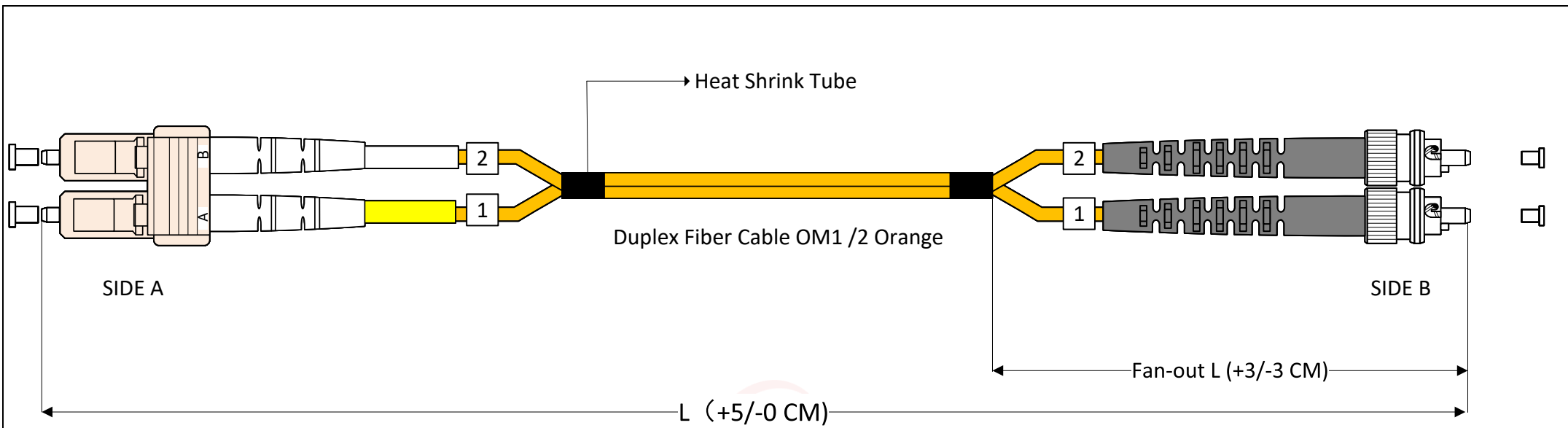

Structural Diagram

### Specification:

- 1.Low Loss IL:  $\leq 0.25\text{dB}$
- 2.Return Loss:  $\geq 35\text{dB}$
- 3.Operation Environment:  $-40\sim+85^{\circ}\text{C}$
- 4.Storage Environment:  $-40\sim+85^{\circ}\text{C}$

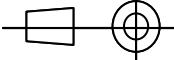
		<b>SHENZHEN OPTICO COMMUNICATION CO., LTD.</b>							
Model	LCUPC-STUPC OM1 /2 Duplex 2.0/3.0mm Orange LSZH CPR-Dca Cable						OP-2F-LCSTU-FP-2.0/3.0- M1/2-DX		
FIRST ANGLE PROJECTION 	MATERIAL	UNIT	SCALE	SIZE	SHEET	DRAWN	XUELING W	DATE	2025.04.29
	LSZH	m	/	A4	1	CHECKED	Michael Liu	DATE	2025.04.29
							APPROVED	STEVEN Zhang	DATE

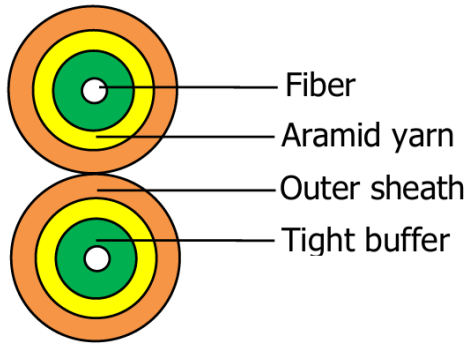
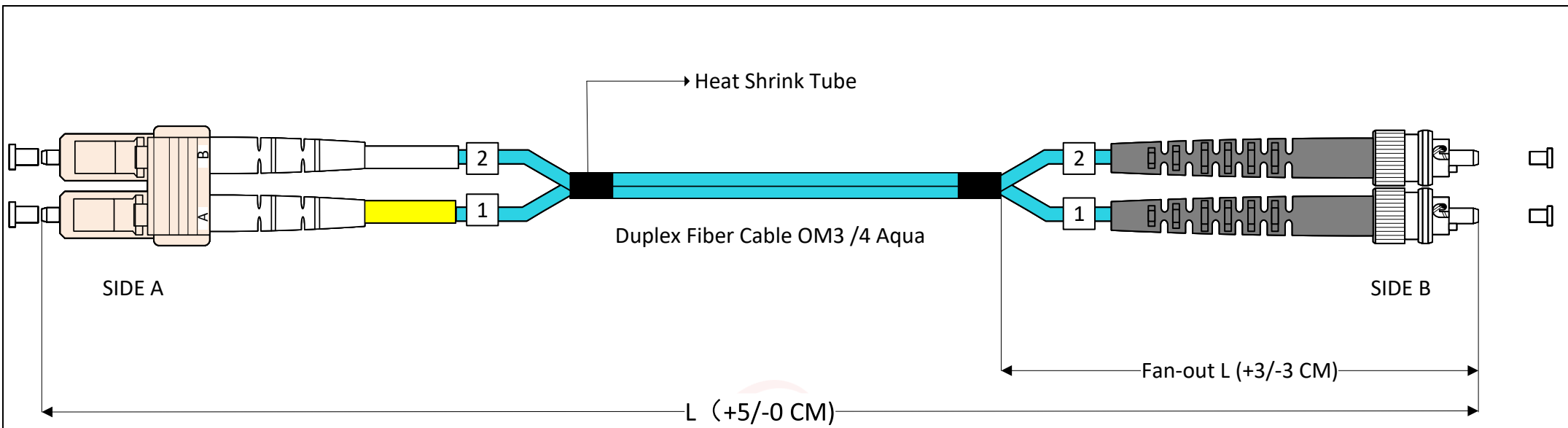

Structural Diagram

### Specification:

- 1.Low Loss IL:  $\leq 0.25\text{dB}$
- 2.Return Loss:  $\geq 35\text{dB}$
- 3.Operation Environment:  $-40\sim+85^{\circ}\text{C}$
- 4.Storage Environment:  $-40\sim+85^{\circ}\text{C}$

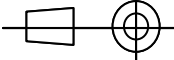
		<b>SHENZHEN OPTICO COMMUNICATION CO., LTD.</b>							
Model	LCUPC-STUPC OM3 / 4 Duplex 2.0/3.0mm Aqua LSZH CPR-Dca Cable						OP-2F-LCSTU-FP-2.0/3.0- M3/4-DX		
FIRST ANGLE PROJECTION 	MATERIAL	UNIT	SCALE	SIZE	SHEET	DRAWN	XUELING W	DATE	2025.04.29
	LSZH	m	/	A4	1	CHECKED	Michael Liu	DATE	2025.04.29
						APPROVED	STEVEN Zhang	DATE	2025.04.29

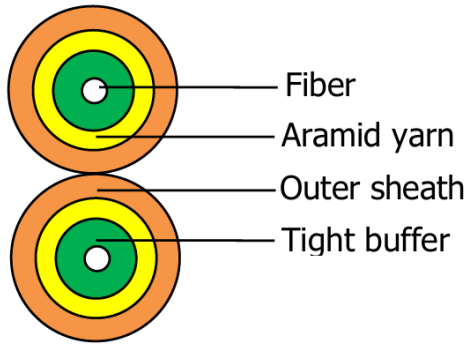
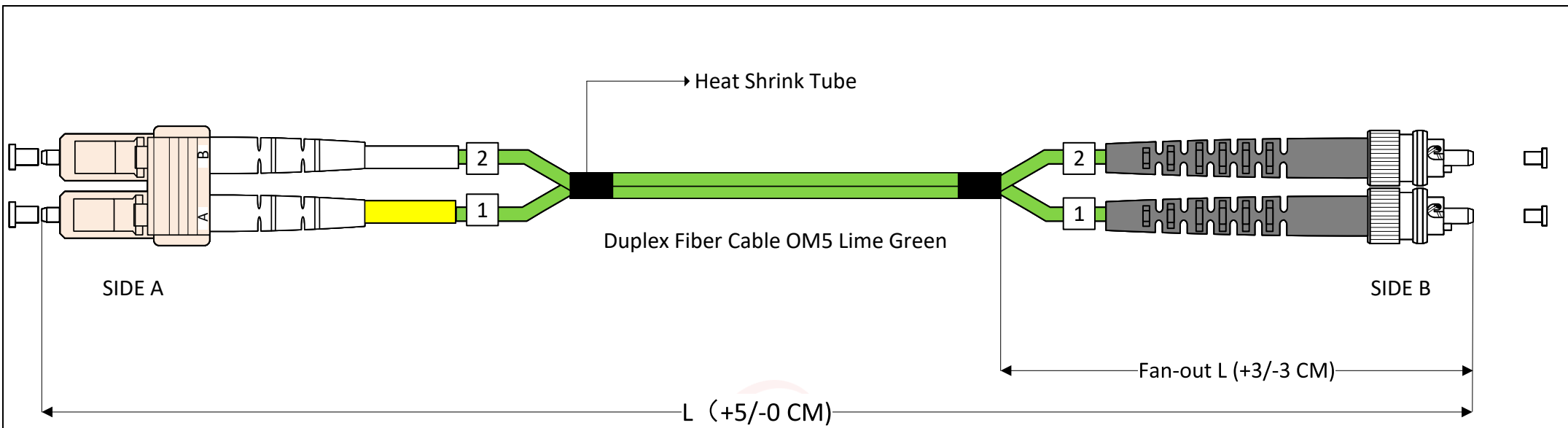

Structural Diagram

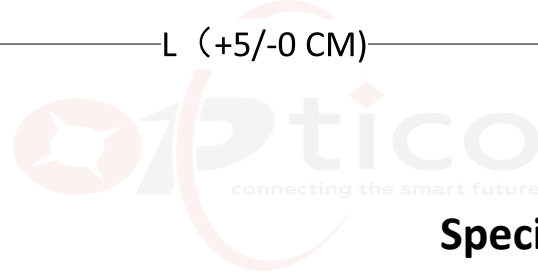

**Specification:**

- 1.Low Loss IL:  $\leq 0.25\text{dB}$
- 2.Return Loss:  $\geq 35\text{dB}$
- 3.Operation Environment:  $-40\sim+85^{\circ}\text{C}$
- 4.Storage Environment:  $-40\sim+85^{\circ}\text{C}$

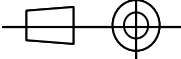
		<b>SHENZHEN OPTICO COMMUNICATION CO., LTD.</b>							
Model	LCUPC-STUPC OM5 Duplex 2.0/3.0mm Lime Green LSZH CPR-Dca Cable					OP-2F-LCSTU-FP-2.0/3.0- M5-DX			
FIRST ANGLE PROJECTION 	MATERIAL	UNIT	SCALE	SIZE	SHEET	DRAWN	XUELING W	DATE	2025.04.29
	LSZH	m	/	A4	1	CHECKED	Michael Liu	DATE	2025.04.29
							APPROVED	STEVEN Zhang	DATE